

# Silhouette®

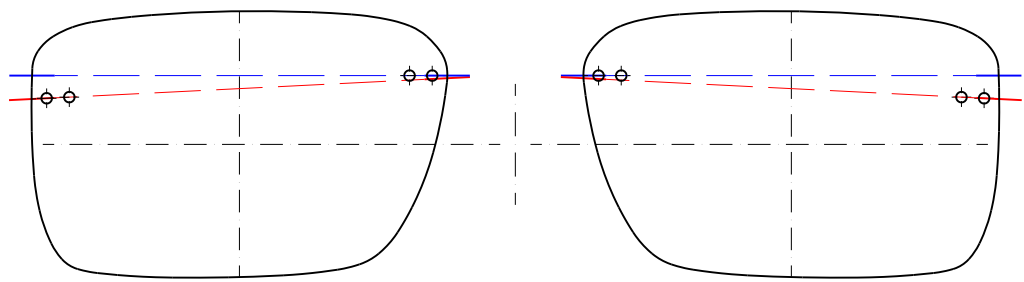

**Attention :**

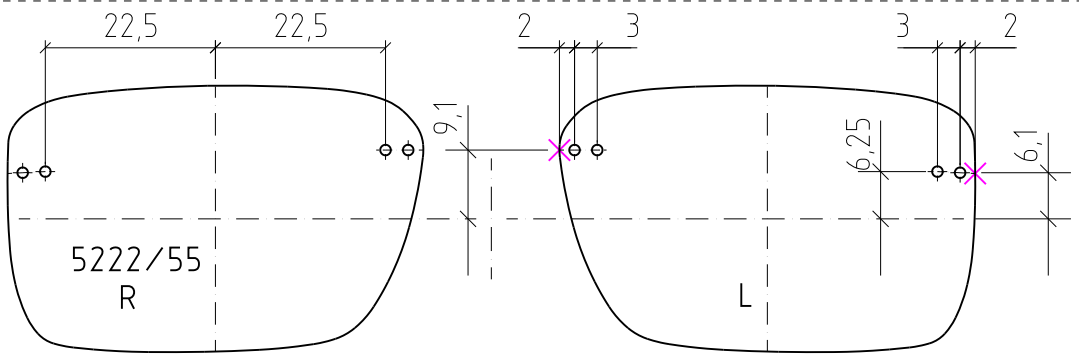
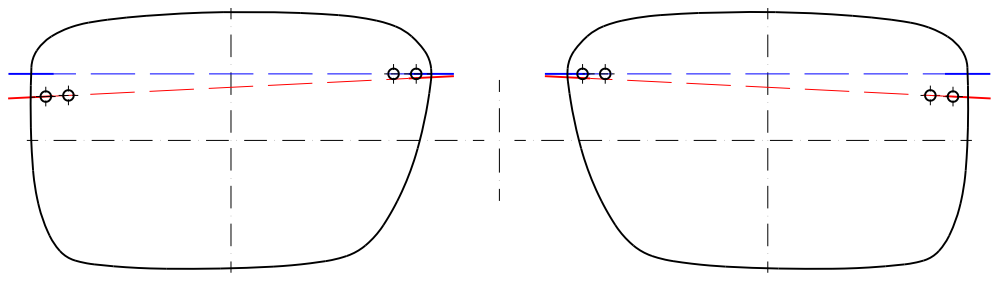
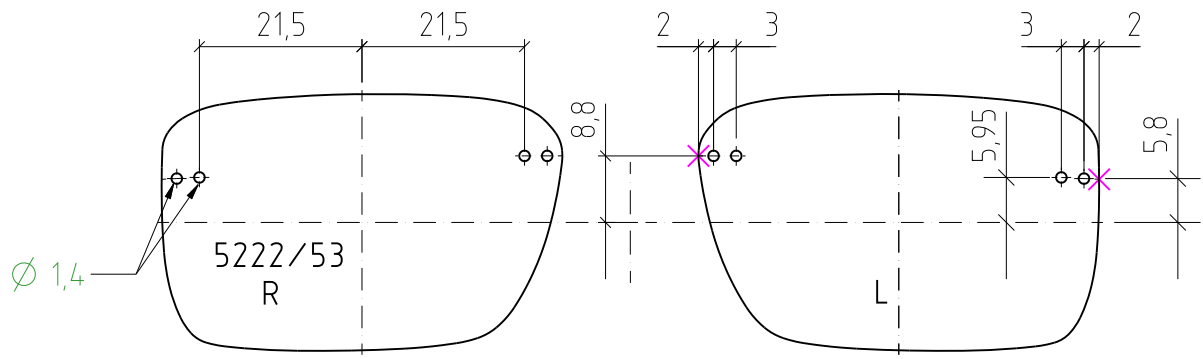
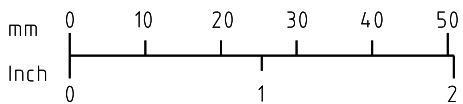

Please check length

✕ = Reference Point

**INSTRUCTIONS**

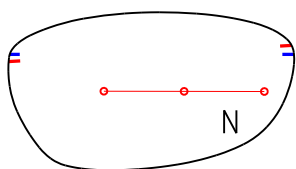

Marked Lens

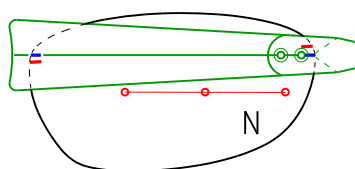

Drilling Jig affixed NASAL

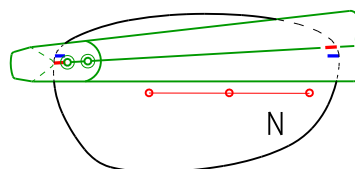

Drilling Jig affixed TEMPORAL

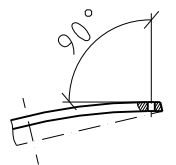

Drilling angle