

# Silhouette

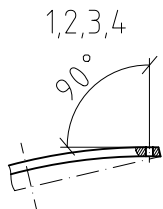

Drilling angle normal to front surface

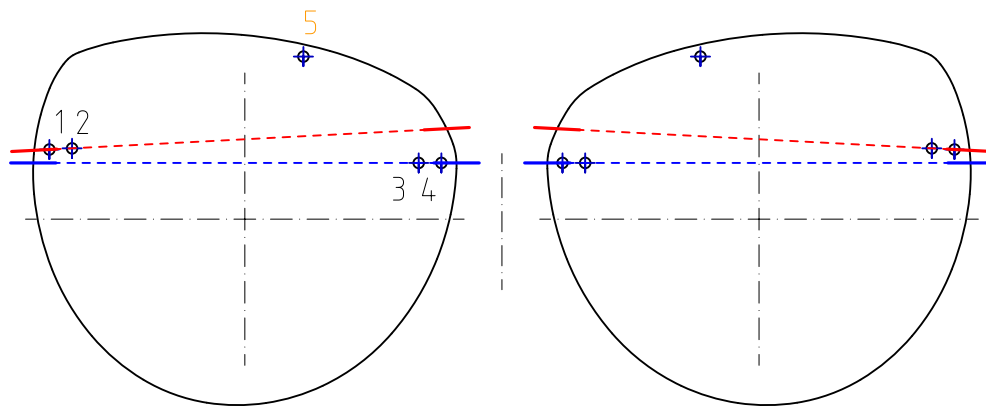
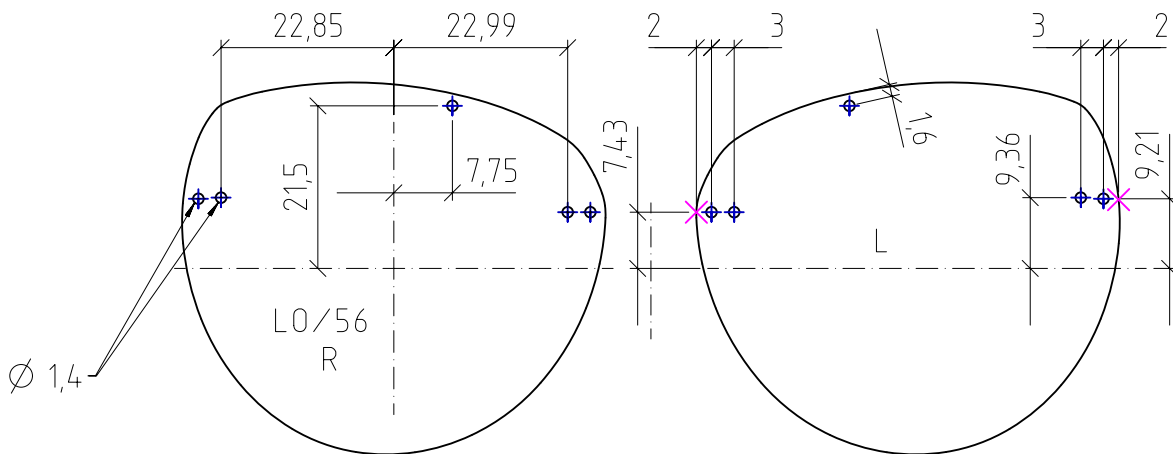
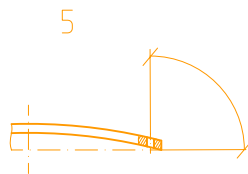

Drilling angle parallel to glass axis

Attention :

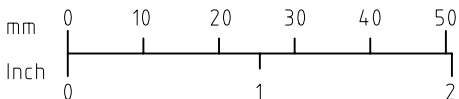

Please check length

X = Reference Point

## INSTRUCTIONS

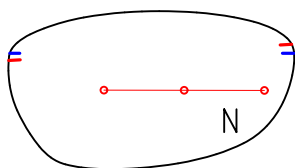

Marked Lens

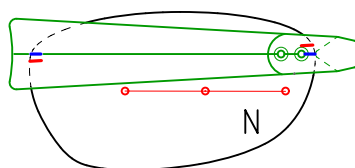

Drilling Jig affixed NASAL

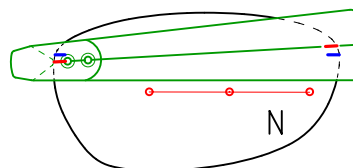

Drilling Jig affixed TEMPORAL